

Mercury Floor Machines, Inc. New Equipment Warranty

Limited Warranty

Mercury Floor Machines, Inc. warrants new equipment against defects in material and workmanship under normal use and service to the original purchaser. Any statutory implied warranties, including any warranty of merchantability or fitness for a particular purpose, are expressly limited to the duration of this written warranty. Mercury Floor Machines, Inc. will not be liable for any other damages, including but not limited to indirect or special consequential damages arising out of or in connection with the furnishing, performance, use or inability to use the machine. This remedy shall be the exclusive remedy of the purchaser. The warranty period is subject to the conditions stated below.

5-Year Warranty on Motor and Chassis, 1-Year Service Labor

Mercury Floor Machines, Inc. warrants electric motors and chassis on all Mercury Floor Machines to be free from defects in material and workmanship, under normal use and service for five (5) years to the original purchaser. Parts replaced or repaired under this warranty are warranted for the remainder of the original warranty period. Service labor charges are covered for one (1) year from the date of purchase, when performed by a Mercury-authorized service provider. Freight charges to and from this service provider will be covered for ninety (90) days from the purchase date. After this ninety (90) day period, these freight charges will be paid by the equipment owner. Travel expenses are not covered.

Wear Items on all Machines

Critical Wear Items - bearings, capacitors, clutches, pulleys, rectifiers, relays, switches, wheels, tires and casters are warranted for manufacturing defects for one (1) year from the purchase date.

Normal Wear Items - belts, brushes, bumpers carbon brushes, cords, finishes, squeegees, actuating cables and gaskets are warranted for manufacturing defects for ninety (90) days from the purchase date.

All warranties of motors and associated components will be voided: if the machine is used as a floor sander; if the machines is serviced by anyone other than a Mercury-authorized service provider; if the machine is mechanically modified; or if the machine is misused or abused.

The warranty starts on the purchase date by the original purchaser from an authorized Mercury Floor Machines, Inc. distributor, subject to proof of purchase. The machine registration card must be completed and returned immediately at the time of purchase. If proof of purchase cannot be identified, the warranty start date is ninety (90) days after the date of sale to an authorized Mercury Floor Machines, Inc. distributor.



Mercury Floor Machines, Inc.
110 South Van Brunt Street
Englewood, NJ 07631
Phone: (201) 568-4606
Toll Free: (888) 568-4606
Fax: (201) 568-7962
www.mercuryfloormachines.com



LO-BOY™ FLOOR MACHINE

SAFETY, OPERATION AND MAINTENANCE MANUAL WITH PARTS LIST

Please read before use!

1.5 HP, 175 RPM

REGISTER
YOUR
MACHINE
ONLINE!



15", 17", 19", 20" and 21" Apron Sizes

5 Apron Sizes

Fully Adjustable

Balanced Design

All Metal Chassis

Quiet Motor

Safe & Easy to Use



IMPORTANT INFORMATION AND SAFETY INSTRUCTIONS

Register your Machine at mercuryfloormachines.com/registration.aspx
Serial No: _____

1.0 Safe Operating Conditions

READ THIS MANUAL BEFORE USING FLOOR MACHINE. KNOW THE PROPER OPERATION, CORRECT APPLICATIONS AND THE LIMITATIONS OF THIS EQUIPMENT **BEFORE** USE.

Reduce the Risk of Fire, Electric Shock or Injury:

- This floor machine is designed for indoor use only. Do not use outdoors. Do not expose to rain.
- Do not wash the motor with flowing water. If the motor gets wet, seek authorized service.
- Keep the vents on this air-cooled motor free from debris. Do not operate with the motor covered or with vents blocked. Do not use this machine as a floor sander.
- Never operate this floor machine near flammable dusts, liquids or vapors. Never use flammable solvents as a cleaning agent. Engine sparks and operating heat can cause fire.
- Never handle electrical equipment with wet hands. Never operate this floor machine with bare feet.
- Unplug the floor machine when not in use and when servicing the equipment. To unplug, grasp the plug not the cord.
- Do not operate a floor machine with damaged handle controls, cord or plug. If the equipment is not performing properly, seek repair from a qualified service supplier.
- This floor machine is constructed with electrical grounding at the plug. Operate only when connected to a properly grounded outlet. See section 1.2 for grounding details.
- Prevent electrical cord abuse. Do not close a door upon the cord, drive equipment over it, or run the floor machine over it. Do not expose the cord to hot surfaces. Do not lift, pull or carry this floor machine by the cord.
- Never operate the floor machine over sharp objects that can be thrown out and harm the operator and damage the floor. Sweep hard floors before scrubbing or buffing. Vacuum clean carpets before shampooing or bonnet cleaning.
- Train your staff in proper use of this floor machine.

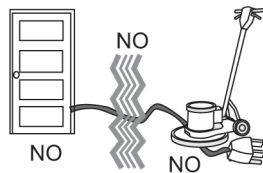
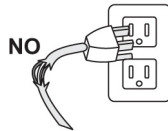
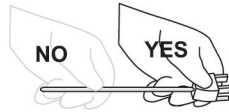

7.2 Scrubbing Brush Filaments

Scrubbing brushes are available with a range of bristle types - from the softest for high-gloss floors, to the most aggressive for heavy soils. Match your brush to the floor as you match a detergent with the soils.



Nylon is used for general scrubbing. Because nylon softens when wet, it is great for gentle scrubbing, mopping and polishing of decorative floors. Nylon will not scratch tile, terrazzo or coated surfaces. Nylon brushes are durable and long lasting.

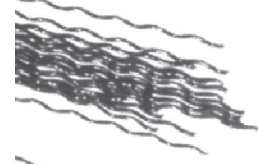

Polypropylene is a common choice for general purpose scrubbing and works well on both concrete and on coated floors. Polypropylene brushes typically cost less than nylon, but do not last as long.



Non-scuff poly is a finer diameter (0.015-0.018”) filament used for lighter duty scrubbing conditions and on waxed or finished floors.



Bassine is a soft, natural fiber. The end of the bristle splits or “flags” to build a polishing surface.



Union mix is a mixture of bassine and tampico (another natural fiber). The mixture is stiffer than bassine alone and is used by more traditional cleaners for scrubbing. It is often replaced by poly.



Soft abrasive bristle is a 0.018” nylon filament extruded with a 500 grade grit. It is used for gentle scrubbing and is as aggressive as a white scrub pad.



Daily abrasive bristle is a 0.035” nylon filament with 180 grade grit. It is used for daily scrubbing of resilient tile and finished floors and is as aggressive as a red scrub pad.

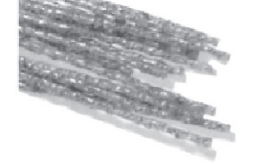

Stripper abrasive bristle is a 0.022” nylon filament with 120 grade grit. It is used for aggressive scrubbing and light stripping of resilient floors, terrazzo and concrete. It is as aggressive as a blue scrub pad.

Heavy-duty stripper abrasive bristle is a 0.050” nylon filament with 80 grade grit. It is used for very aggressive scrubbing and stripping of concrete, brick and quarry tile. It is as aggressive as a black scrub / strip pad.

7.0 Brush Construction

Your new floor machine provides reliable, efficient, safe power to your scrubbing brush. To get the best results, you need to use a brush of the best design and construction.

Your floor machine is built with a “B” style drive plug (1). The height and width of the ears on the plug will match a “B” style or “Universal” clutch plate (2) mounted on the brush block.

The brush block (3) is constructed of molded plastic or this plywood. Use a brush with a block diameter 2” less than your machine apron size.

The bristle material (4) that actually does the scrubbing is typically 1-1/2” to 2” long. Holes are drilled in the block and bundles of bristles are folded in half, forced into the hole and stapled in place (staple-set).

When the bristles wear down to less than 1/2” long, they have little flexibility and it’s time to replace. Bristle materials are described on page 11.

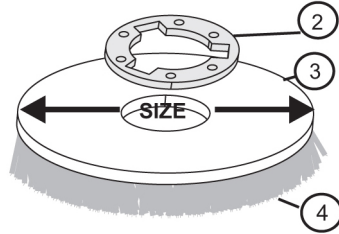
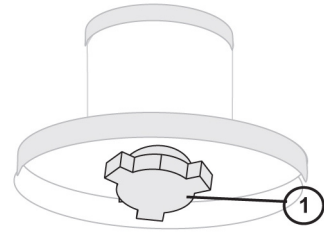

7.1 Pad Driver Construction

If you scrub or polish with a non-woven pad, use a pad driver to connect the pad to the machine.

The brush block (3) is constructed of molded plastic, fit with shorter, stiffer, pad-holding bristles (5) or “velcro-like” pad-holding hooks (6) and use a riser (7) to create extra clearance between the block and the machine apron. With this construction, use a pad driver with block diameter 1” less than your machine apron size.

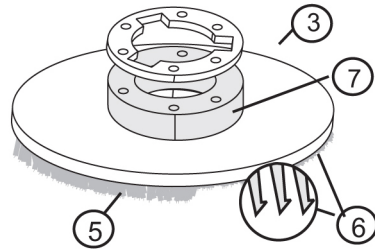

Machine Apron Size	15”	17”	19”	20”	21”
Pad Driver - with 3/4” Riser	14”	16”	18”	20”	20”
Brush - with NO RISER	13”	15”	17”	19”	19”

1.1 Electrical Power

This floor machine operates on a 15 amp nominal 115V, 60 Hz, A.C. power circuit. (Motors may be custom wired at the factory 220V, 50 Hz international operation.) The amp, hertz and voltage ratings are listed on the motor spec label found on each floor machine. Using voltages above or below those indicated on the spec label will damage the motor. Always check your local voltage requirements.

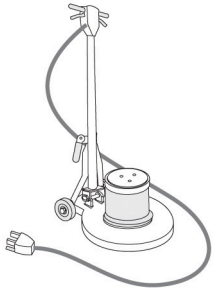

1.2 Grounding Instructions

This floor machine must be grounded while in use to protect the operator from electrical shock. This machine is built with a 3-wire cord and a 3-prong grounding-type plug (Figure 1) to fit a properly grounded receptacle.

Before using this floor machine, make sure a properly grounded, 3-hole electrical outlet is available. If not available, as in some older facilities, use an adaptor for connecting a 3-prong plug to a 2-prong receptacle (Figure 2) to ground the outlet chassis.

IMPORTANT: This adaptor may not be used in Canada.

IMPORTANT: Never cut off the grounding prong for use in a 2-prong outlet. By doing so, you have cut off your protection from electrical shock.

Never assume that all 3-hole outlets are properly grounded. Check before use.

Never assume that an adaptor connection (as in Figure 2) is properly grounded. Check the outlet with a ground fault interrupter device which quickly indicated if a ground is connected. Correct a faulty grounding before proceeding.

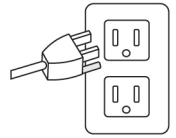

Figure 1

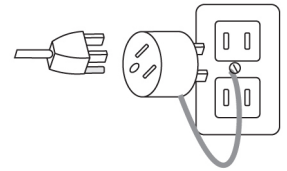

Figure 2

1.3 Extension Cords are Not Recommended

The floor machine is built with a 50 foot (15 M) safety cord which plugs directly into an approved outlet. Use of any extension cords is NEVER RECOMMENDED.

2.0 Install the Handle

This machine handle (1) has been custom fit to its mounting yoke (2) at the factory and then taken apart for shipping. For easy assembly, make sure that the handle number on the tag (see right) matched the serial number stamped on the chassis.

You will need 7/16" wrenches to complete the assembly:

1. Remove the handle and mounting hardware from the carton. Bolts, nuts, washers and the locking lever assembly are in the plastic bag attached to the handle.
2. Position the handle (1) over the mounting yoke (2) with the power cord (3) facing away from the motor. Push the tube down until the bolt holes are lined up.
3. Insert the long mounting bolt (4) into through the aligned holes in the yoke and mounting ears (2). Secure the bolt with a locking nut (5).
4. The handle mounting collar (6) is designed to slide freely up and down the handle tube (7). This feature allows the handle to be adjusted for the comfortable operation of all users.
5. Remove the lever assembly parts from the plastic bag.
 - Align the mounting collar (6) and the two bent handle braces (7).
 - Place the thick spacer with a rectangular neck of the lever.
 - Insert the shaft through the mounting hole in the right handle brace, the mounting collar and the left handle brace.
 - Place a spacer (11) on the shaft.
 - Place the locking wing nut (13) on the shaft.
 - Adjust the wing nut for tightness. When correctly installed, the collar slides easily when the cam-engineered locking lever is "up," but is firmly fixed when the lever is "down."

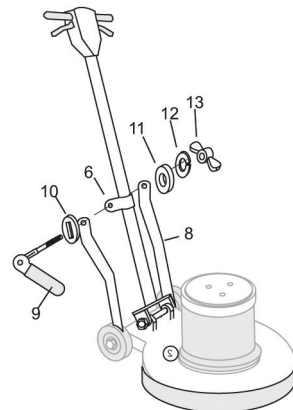
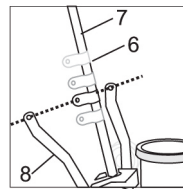
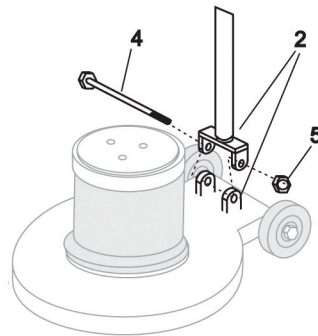
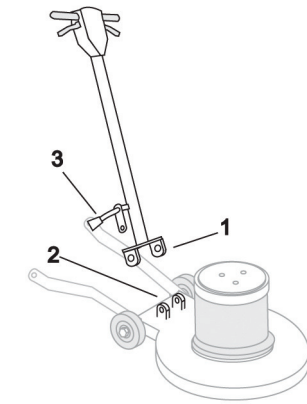

5.2 Transport

To transport this floor machine from the janitor's closet to the work area:

- Lock the handle in the "up" position. Wind the cord around the handles and the bottom cord hook.
- Tip the machine back onto the transport wheels. Push or pull the machine by the handle, not by the cord or any other part of the machine. Travel carefully.

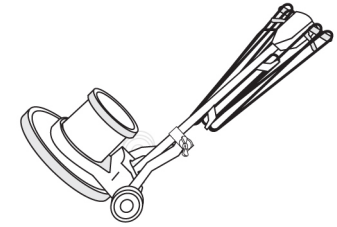

6.0 Troubleshooting

Never operate this floor machine when the equipment is not performing as expected or when any part is visibly damaged. The cause and solution for some basic problems are described below. When repair is needed, take the equipment to an authorized repair service center.

6.1 Floor Machine will not Run

- Circuit breakers are tripped in the building. **Check and reset.**
- Equipment is unplugged. **Check plug wall and at machine base. Plug in.**
- Power cord failure. **Test with a working power cord. Lock the handle up and tip the motor back. Unplug the cord at the motor and plug the motor into your working power cord.**
- IMPORTANT! THIS IS JUST FOR TESTING. When you do this, you have removed the safety handle controls from the circuit and you are sending power directly to the motor. If the motor now spins, the problem is in the cord of the handle assembly. **Seek authorized repair service.**
- If the motor still does not spin, the problem is either in the male connection at the motor base or in the motor. **Seek authorized repair service.**
- Motor sparks or smokes. **Seek authorized repair service.**

6.2 Electrical Shock to Operator

- Equipment wiring failure or electrical short in the machine. **Seek authorized service.**
- Poor grounding or no grounding. **Test the outlet with a ground fault interrupter. Retain certified electrician to inspect and repair grounding. NEVER clip off the ground plug on your cord.**
- Repeated circuit breaking. High amp draw and circuit breaking can be an electrical or mechanical problem. **Seek authorized repair service.**

6.3 High Vibration

- Pads are not centered on the pad driver. **Tip machine back and re-center the pad.**
- Uneven wear or warp to pad or brushes. **Replace.**
- Machine chassis is damaged by dropping. **Replace.**

5.0 Operating Tips

- For indoor use only. Sweep abrasive soils before scrubbing.
- While the brush or pad driver is spinning, keep the floor machine moving to avoid “donut” burns on the floor.

To Start Operation:

- Unlock the handle by raising the locking lever.
- Lower the handle to a comfortable position, typically waist height.
- Relock the handle by pushing the lever down. **NEVER OPERATE THE MACHINE WITH THE HANDLE UNLOCKED.**
- This floor machine is a high torque motor. Hold the machine firmly with both hands when starting up.
- Push the red safety interlock switch forward to unlock the dual triggers.
- Squeeze the dual triggers to release power to the motor. Once power is on, either trigger will keep power to the motor.
- To stop the floor machine release both triggers.
- The spinning brush helps move the floor machine. (Lift the handle slightly to work to the right. Push the handle down slightly to work to the left.)

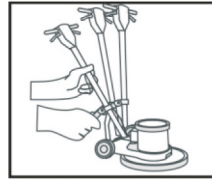

SET HANDLE HEIGHT

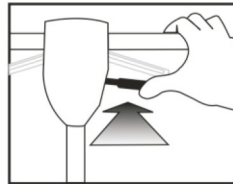

PUSH LOCK FORWARD

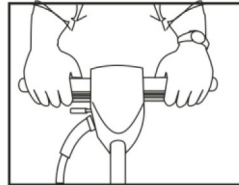

SQUEEZE BOTH TRIGGERS

5.1 To Store your Machine

- Lock the handle in the “up” position. Tilt the machine back and remove the pad driver or brush.
- Wind the cord around the handles and the bottom cord hook.
- Wash brushes or pads and hang to dry. Never store machine standing on the brush.
- Inspect and maintain equipment on a regular schedule for best results.
- Check and clean pads after each operation. Remove soil and chemical buildup. Replace worn or damaged pads.
- Check the triggers and switches for proper operation.
- Repair or replace damaged skirts and dumpers.
- Use air pressure or vacuum to remove dust and debris from the motor vents.
- Report problems and repair promptly.

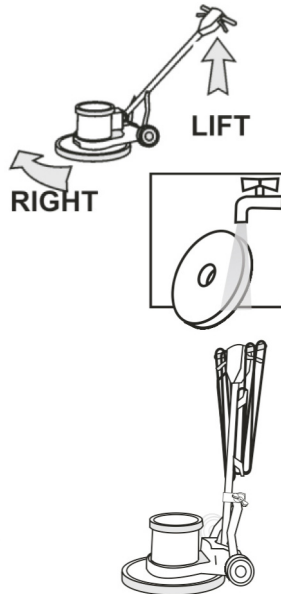

2.1 Attach the Power Cord

The triple-wire grounded power cord has been factory-installed into the handle tube. A flexible rubber cable connector (11) is used to secure the plug-in connections. The floor machine ships with this connector mounted on the cord coming out of the handle (10). Stretch the connector and slip the male connector (9) (coming out of the motor housing) through the connector hole and then into the female connector.

Now, plug the end of the 50-foot cord into a grounded power outlet. Squeeze the triggers on the handle and check for power to the motor.

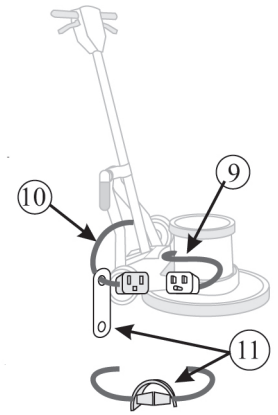

2.2 Install a Brush or Pad Driver

A brush or pad driver mounts onto your floor machine with a “B” style Universal clutch plate.

Unplug the floor machine. Lock the machine handle in the “up” position and tip the floor machine back onto the handle.

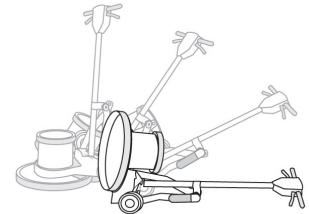

Slide the brush or pad driver clutch plate (12) over the drive plug (13).

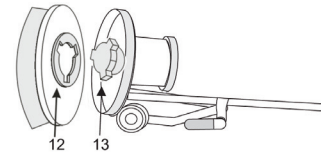

Give the brush a quick counter-clockwise spin to lock the brush onto the drive plug.

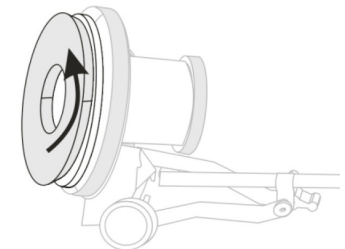

Now, lower the machine back onto the brush.

You're ready to go to work.

3.0 Machine Schematic Drawing

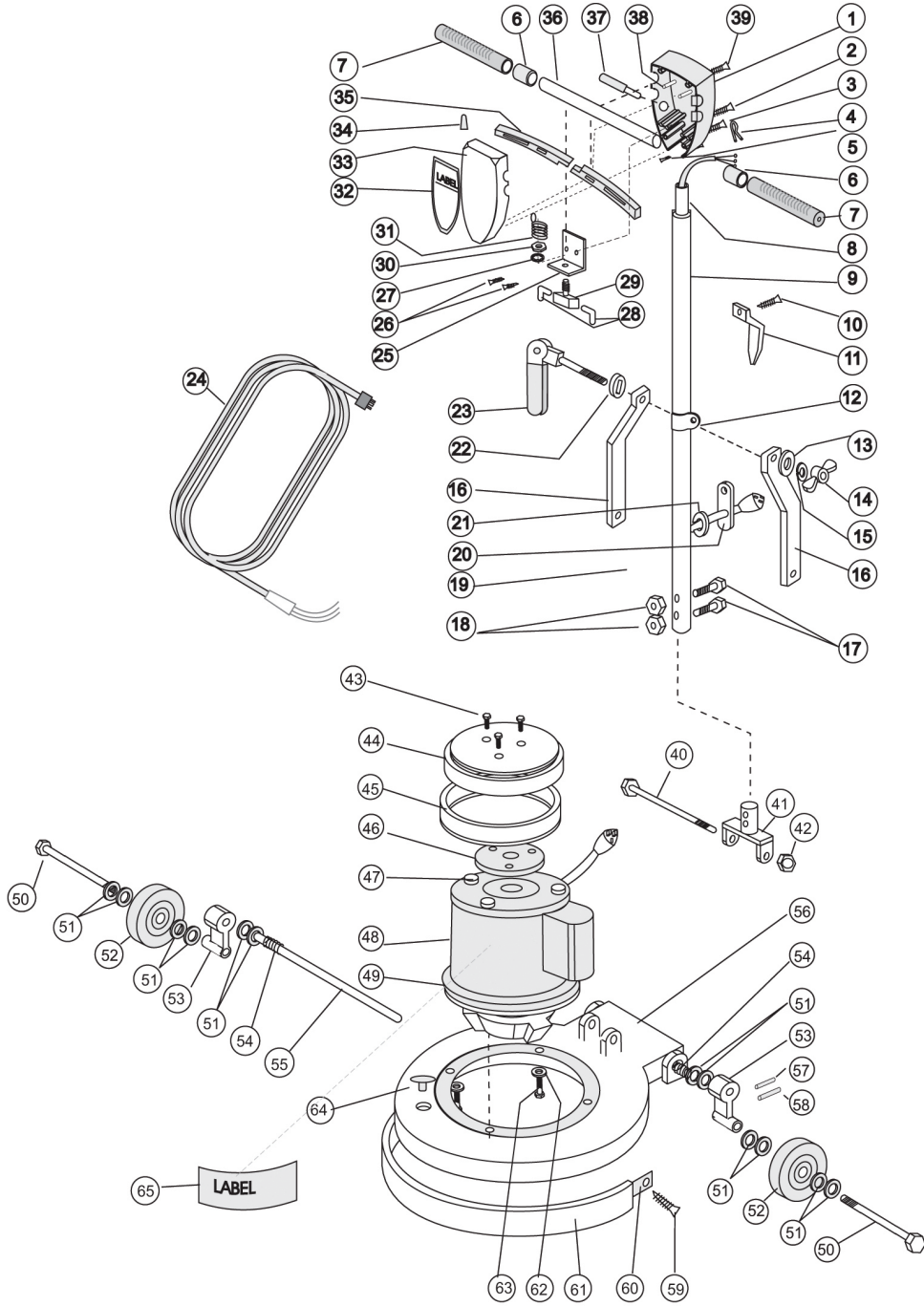

(6) Super Heavy-Duty Floor Machine

4.0 Machine Parts List

Item	Description	Part No.	Qty. Needed
1	Switch Box Back	A-104	1
2	Handle Tube Screw	B-23	2
3	Switch Box Closing Screw	B-21	4
4	Strain Relief Clip	M-213	1
5	Ground Wire Screw	B-68	2
6	Rubber Spacer - Yellow	M-218-Y	2
7	Hand Grip	M-218	2
8	Handle Tube Insert	M-247	1
9	Handle Tube Assembly	M-206	1
10	Cable Hook Screw	B-2	2
11	Cable Hook	A-164	1
12	Sliding Collar	A-111	1
13	Oval Hole Cam Washer	B-37	1
14	Cam Lock Wing Nut	B-25	1
15	Cam Split Washer	B-39	1
16	Bent Brace	M-216	2
17	Yoke Bolt	B-18A	2
18	Yoke Nut	B-19	2
19	Handle Tube Cable	G-16	1
20	Black Rubber Cable Connector	M-249	1
21	Cable Grommet	B-63	1
22	Rectangular Hole Cam Washer	B-67	1
23	Cam Assembly	C-100	1
23A	Complete Cam Assembly Kit (Includes 1 each of Drawing Items #13, 14, 15, 22, 23)	CCA	1
24	50-Foot Cable, 14/3-Gauge - Yellow	G-14-50	1
25	Switch Mounting Plate	G-30-B	1
26	Switch Plate Screw	B-1	2
27	Int. Tooth Lock Washer (for Switch)	B-35	1
28	Insulated Flag Wire Connector	G-48	2
29	On-Off Switch And Plate Assembly	G-30-AB	1
30	Lock Washer	B-33	1
31	Trigger Return Spring	G-30-CT057	1
32	Label For Switch Box	A-103	1
33	Switch Box Front	G-47	1
34	Wire Connector	A-105	2
35	Trigger	M-211-A	1
36	16" Crossbar	SIA-1	1
37	Safety Interlock Assembly	B-70	2
38	Trigger Pin	B-22	2
39	Crossbar Screw	B-14	1
40	Yoke Bolt	A-1001	1
41	Yoke	B-10	1
42	Acorn Nut For Yoke Bolt	B-151	3
43	Drip Cap Mounting Screw	M-241	1
44	66-Frame Drip Cap Cover	M-239	1
45	66-Frame Drip Cap Cover Bumper	M-248	1
46	Cork Drip Cap Gasket	B-32	4
47	Split Washer	MOTOR /GB-LH/E	1
48	Motor 66 Frame 1.5 HP With Gearbox, 115V	GB96008	1
49	Gear Box, 11:1, Triple Planetary	B-15, BDP	2
50	Wheel Axel Bolt	B-51	12
51	Spring Washer	M-245	2
52	6" Wheel	A-117	2
53	Wheel Carriage	B-30	2
54	Spring	M-217	1
55	9" Axel	A-124	1
56A	Base Casting 15"	A-134	1
56B	Base Casting 17"	A-127	1
56C	Base Casting 19"	A-129	1
56D	Base Casting 20"	A-129	1
56E	Base Casting 21"	B-45	2
57	Axel Pin	B-46	2
58	Wheel Axel Pin	B-68	2
59	Bumper Screw	Bumper Strap	2
60	Bumper Strap 15" (order 43" of Bumper Strap)	M-232-15/Y	1
61A	Bumper 15" - Yellow	M-232-17/Y	1
61B	Bumper 17" - Yellow	M-232-19/Y	1
61C	Bumper 19" - Yellow	M-232-21/Y	1
61D	Bumper 20" - Yellow	M-232-21/Y	1
61E	Bumper 21" - Yellow	M-232-21/Y	1
62	1/4" Medium Split Washer	B-32	3
63	Cap Screw	B-31	3
64	Scrubber Plug	B-50	1
65	Label for Motor		1

Super Heavy-Duty Floor Machine (7)